



Austrian Institute of Construction Engineering
Schenkenstrasse 4 | T+43 1 533 65 50
1010 Vienna | Austria | F+43 1 533 64 23
www.oib.or.at | mail@oib.or.at



European Technical Assessment

ETA-22/0816
of 31.03.2023

General part

Technical Assessment Body issuing the European Technical Assessment

Österreichisches Institut für Bautechnik (OIB)
Austrian Institute of Construction Engineering

Trade name of the construction product

MFT-FOX V and MFT-FOX VI
wall brackets, profiles and panel fixing elements

Product family to which the construction product belongs

Kit composed by subframe and fixings for fastening cladding and external wall elements

Manufacturer

HILTI Corporation
Feldkircherstrasse 100
9494 Schaan
Liechtenstein

Manufacturing plant

Hilti Austria Industrie GmbH
Gewerbepark C7
2821 Lanzenkirchen
Austria

This European Technical Assessment contains

29 pages including 8 Annexes

This European Technical Assessment is issued in accordance with Regulation (EU) No 305/2011, on the basis of

European Assessment Document (EAD)
090034-00-0404 – Kit composed by subframe and fixings for fastening cladding and external wall elements

Specific parts

1 Technical description of the product

1.1 Definition of the product

The kit comprises subframes and fixings for fastening skin elements, such as wall brackets MFT-FOX V, MFT-FOX VI, isolator, connectors, profiles and panel fixing elements. All these components fall within the scope of EAD 090034-00-0404. The construction products included in this kit are of various natures, which are factory produced by the ETA holder or different suppliers, are identified in Table 1 and have the geometrical characteristics defined in Annexes 1 – 3. The ETA holder is ultimately responsible for the kits.

Table 1 - List of elements composing the kit

Name	Element	Definition	Material
MFT-FOX V	Bracket	Wall brackets	Aluminum EN AW-6063 T66
MFT-FOX VI	Bracket	Wall brackets	Aluminum EN AW-6063 T66
	Isolator	Thermal insulation between bracket and wall	Polypropylene with fire retardant
Hilti S-AD01 S 5,5x19 (A2)	Screw	Connectors between brackets and profiles	Stainless steel A2
Hilti S-AD01 SS 5,5x19 (A4)	Screw	Connectors between brackets and profiles	Stainless steel A4
Hilti S-AD01 S 5,5x16 (A2)	Screw	Connectors between brackets and profiles	Stainless steel A2
Hilti S-AD01 SS 5,5x16 (A4)	Screw	Connectors between brackets and profiles	Stainless steel A4
Hilti S-AD01 L(P)SS 5,5x25 (A4)	Screw	Connectors between brackets and profiles	Stainless steel A4
Hilti S-AD01 LHS M (A2)	Screw	Connectors between brackets and profiles	Stainless steel A2
Hilti S-AD01 LHSS 4,8x17 (A4)	Screw	Connectors between brackets and profiles	Stainless steel A4
MFT-CVM 9-12	Clamp	Skin element fixing: Type 3	Stainless steel A2
MFT-CVE 9-12	Clamp	Skin element fixing: Type 3	Stainless steel A2
MFT-CVB 9-12	Clamp	Skin element fixing: Type 3	Stainless steel A2
MFT-CVM 7,5	Clamp	Skin element fixing: Type 3	Stainless steel A2
MFT-CVE 7,5	Clamp	Skin element fixing: Type 3	Stainless steel A2
MFT-CVB 7,5	Clamp	Skin element fixing: Type 3	Stainless steel A2
MFT-CHM	Clamp	Skin element fixing: Type 3	Stainless steel A2
MFT-CHB	Clamp	Skin element fixing: Type 3	Stainless steel A2
MFT-CHE	Clamp	Skin element fixing: Type 3	Stainless steel A2
MFT-SPM	HSP	Skin element fixing: Type 4	Aluminum EN AW-6063 T66
MFT-SPB	HSP	Skin element fixing: Type 4	Aluminum EN AW-6063 T66
MFT-SPT	HSP	Skin element fixing: Type 4	Aluminum EN AW-6063 T66
MFT-SPJ	HSP	Skin element fixing: Type 4	Aluminum EN AW-6063 T66
MFT-Z SZ20	HSP	Skin element fixing: Type 4	Aluminum EN AW-6063 T66
MFT-B SZ20	HSP	Skin element fixing: Type 4	Aluminum EN AW-6063 T66
MFT-S SZ20	HSP	Skin element fixing: Type 4	Aluminum EN AW-6063 T66
MFT-H 200/150 K	Hanger	Skin element fixing: Type 5	Aluminum EN AW-6063 T66
MFT-H 200/40 K	Hanger	Skin element fixing: Type 5	Aluminum EN AW-6063 T66
MFT-H 200/50 RL 9.2	Hanger	Skin element fixing: Type 5	Aluminum EN AW-6063 T66
MFT-HA 200/150 K	Hanger	Skin element fixing: Type 5	Aluminum EN AW-6063 T66
MFT-HA 200/40 K	Hanger	Skin element fixing: Type 5	Aluminum EN AW-6063 T66
MFT-HA 200/50 RL 9.2	Hanger	Skin element fixing: Type 5	Aluminum EN AW-6063 T66
MFT-HAF 200/150 K	Hanger	Skin element fixing: Type 5	Aluminum EN AW-6063 T66
MFT-HAF 200/40 K	Hanger	Skin element fixing: Type 5	Aluminum EN AW-6063 T66
MFT-HAF 200/50 RL 9.2	Hanger	Skin element fixing: Type 5	Aluminum EN AW-6063 T66
MFT-H 200/50 T	Hanger	Skin element fixing: Type 5	Aluminum EN AW-6063 T66
MFT-HA 200/50 T	Hanger	Skin element fixing: Type 5	Aluminum EN AW-6063 T66
MFT-HAF 200/50 T	Hanger	Skin element fixing: Type 5	Aluminum EN AW-6063 T66
MFT-H 300/50 T	Hanger	Skin element fixing: Type 5	Aluminum EN AW-6063 T66
MFT-HA 300/50 T	Hanger	Skin element fixing: Type 5	Aluminum EN AW-6063 T66
MFT-HAF 300/50 T	Hanger	Skin element fixing: Type 5	Aluminum EN AW-6063 T66
MFT-H 300/50 RL 9,2	Hanger	Skin element fixing: Type 5	Aluminum EN AW-6063 T66
MFT-H 300/40 K	Hanger	Skin element fixing: Type 5	Aluminum EN AW-6063 T66
MFT-H 300/150 K	Hanger	Skin element fixing: Type 5	Aluminum EN AW-6063 T66

Name	Element	Definition	Material
MFT-HA 300/50 RL 9,2	Hanger	Skin element fixing: Type 5	Aluminum EN AW-6063 T66
MFT-HA 300/40 K	Hanger	Skin element fixing: Type 5	Aluminum EN AW-6063 T66
MFT-HA 300/150 K	Hanger	Skin element fixing: Type 5	Aluminum EN AW-6063 T66
MFT-HAF 300/50 RL 9,2	Hanger	Skin element fixing: Type 5	Aluminum EN AW-6063 T66
MFT-HAF 300/40 K	Hanger	Skin element fixing: Type 5	Aluminum EN AW-6063 T66
MFT-HAF 300/150 K	Hanger	Skin element fixing: Type 5	Aluminum EN AW-6063 T66
MFT-L 60 × 50 × 2 mm	L Profile	Profile	Aluminum EN AW-6063 T66
MFT-L 50 × 42 × 2 mm	L Profile	Profile	Aluminum EN AW-6063 T66
MFT-L 40 × 40 × 1,8 mm	L Profile	Profile	Aluminum EN AW-6063 T66
MFT-L 60 × 40 × 1,8 mm	L Profile	Profile	Aluminum EN AW-6063 T66
MFT-L 60 × 40 × 2 mm	L Profile	Profile	Aluminum EN AW-6063 T66
MFT-L 60 × 40 × 2,2 mm	L Profile	Profile	Aluminum EN AW-6063 T66
MFT-T 60 × 100 × 2 mm	T Profile	Profile	Aluminum EN AW-6063 T66
MFT-T 60 × 100 × 2,2 mm	T Profile	Profile	Aluminum EN AW-6063 T66
MFT-T 60 × 140 × 2 mm	T Profile	Profile	Aluminum EN AW-6063 T66
MFT-T 60 × 140 × 2,2 mm	T Profile	Profile	Aluminum EN AW-6063 T66
MFT-T 40 × 80 × 1,8 mm	T Profile	Profile	Aluminum EN AW-6063 T66
MFT-T 40 × 120 × 2 mm	T Profile	Profile	Aluminum EN AW-6063 T66
MFT-T 60 × 80 × 1,8 mm	T Profile	Profile	Aluminum EN AW-6063 T66
MFT-T 60 × 100 × 1,8 mm	T Profile	Profile	Aluminum EN AW-6063 T66
MFT-T 60 × 120 × 1,8 mm	T Profile	Profile	Aluminum EN AW-6063 T66
MFT-T 60 × 120 × 2 mm	T Profile	Profile	Aluminum EN AW-6063 T66

MFT-FOX V is an L-shaped bracket made of aluminium (EN AW-6063 T66) as part of the substructure for ventilated exterior wall cladding systems. A helping clip with the function of holding the profile during the installation process is present on the longer side of the bracket. The shorter side of the bracket is attached to the exterior wall through approved anchoring / fixing systems (dowels, anchors, screws, direct fastening nails).

MFT-FOX VI consists MFT-FOX V plus thermal isolator. This insulator is made of polypropylene and is placed at the base of the bracket (Figure 1). The brackets are available in three sizes: small (S), medium (M), and large (L). Their dimensions are reported in Table 2. FOX VI length (L) is equal to the thermal isolator thickness (L1) plus the FOX V length (L2).

Table 1 - Bracket's dimensions

L [mm]	40 – 60 – 80 – 100 – 120 – 140 – 160 – 180 – 200 – 220 – 240 – 260 – 280 – 300
L1 [mm]	6
L2 [mm]	34 – 54 – 74 – 94 – 114 – 134 – 154 – 174 – 194 – 214 – 234 – 254 – 274 – 294
H [mm]	50 (S) – 75 (M) – 150 (L)
B [mm]	46

The skin elements, thermal insulation layers and the fixing between the supporting structure and the brackets not covered by this European Technical Assessment. Detailed information and data on all components are given in the annexes of this ETA and in the associated test reports.

Figure 1 - Side and top-view of the bracket

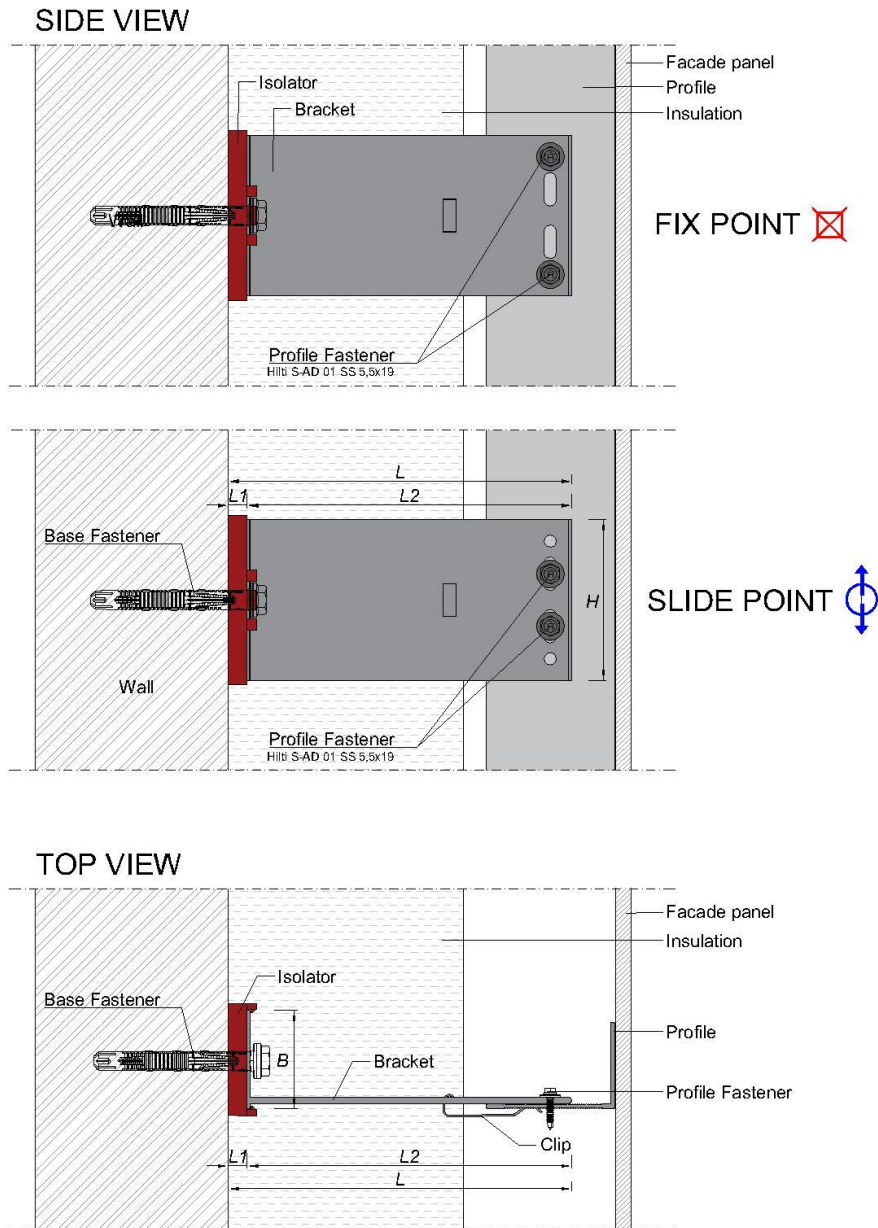

2 Specification of the intended use(s) in accordance with the applicable European Assessment Document (hereinafter EAD)

2.1 Intended use

All products are used in facades with air space, ventilated or not and intended to be fixed to the supporting structure by means of anchors. The brackets are anchored or fixed to the external walls of buildings as load-transferring structural components of the facade.

Brackets MFT-FOX V and FOX-VI are used for vertical layouts of the substructure. At the front end of the cantilever part of the brackets, L or T profiles are connected to the brackets by means of self-drilling screws. The wall's characteristics shall be verified before using the brackets, especially regarding fire classification and suitability for mechanical anchoring.

The brackets are non-structural elements and do not contribute to the stability of the wall on which they are installed. At the same time, the entire kit included in this document has the role of transferring the load (panel self-weight and wind load) to the wall.

electronic copy

2.2 Working life

The provisions made in this European Technical Assessment are based on an assumed working life of the load-bearing system of 25 years.

The indications given on the intended working life cannot be interpreted as a guarantee given by the producer or the Technical Assessment Body, but are to be regarded only as a means for selecting the appropriate product in relation to the expected economically reasonable working life of the works.

2.3 Manufacturing

The European Technical Assessment is issued for the product on the basis of agreed data / information, deposited with the Österreichisches Institut für Bautechnik, which identifies the product that has been assessed and judged. Changes to the product or production process, which could result in this deposited data / information being incorrect, should be notified to the Österreichisches Institut für Bautechnik before the changes are introduced.

The Österreichisches Institut für Bautechnik will decide whether or not such changes affect the European Technical Assessment and consequently the validity of the CE marking on the basis of the European Technical Assessment and if so whether further assessment or alterations to the European Technical Assessment, shall be necessary.

2.4 Installation

The product shall be installed according to technical descriptions and manuals of the ETA-holder.

2.5 Maintenance and repair

Maintenance is not required during the intended working life.

3 Characteristics of product and assessment

The assessment of "MFT-FOX V and MFT-FOX VI" for the intended use was performed following the EAD 090034-00-0404.

Basic Works Requirement	ETA clause	Essential characteristics	Assessment of characteristics
BWR 2			
Safety in case of fire	3.1	Reaction to fire	see clause 3.1
BWR 4			
Safety and accessibility in use	3.2	Wind load resistance	see Annex A
	3.3	Resistance to vertical load of the whole assembled system	see Annex B
	3.4	Resistance to vertical load of skin element fixings	see Annex C.1
	3.5	Resistance to horizontal load of skin element fixings	see Annex C.2
	3.6	Resistance to pulsating load of skin element fixings	NPD
	3.7	Resistance of skin element fixings in case of inaccuracies of installation	NPD
Safety and accessibility in use	3.8	Pull-through resistance of fixings (from profiles)	NPD
	3.9	Pull-out resistance of fixings (from profiles)	NPD
	3.10	Inertia and resistance of profiles	see Annex D
	3.11	Resistance to vertical load of brackets	see Annex E
	3.12	Resistance to horizontal load of brackets	see Annex F
	3.13	Mechanical characteristics of subframe fixings	see Annex G
	3.14	Corrosion	see clause 3.14

3.1 Reaction to fire

The reaction to fire class of the brackets was verified from the reaction to fire classification of their components.

The main components of the kit are made of aluminium and stainless steel. Therefore, the brackets comply with the requirements of class A1, in accordance with EC Decision 96/603/EC (as amended) without the need for testing based on the list in that decision.

According to clause 2.1 of TR 021 "Reaction to fire requirements for small components", edition June 2005, it can be assumed that a component with mass ≤ 50 g is a small component and does not need to be tested and classified separately. The optional thermal break of the brackets fulfil those criteria, therefore these components do not need to be tested for their reaction to fire performance.

3.2 Wind load resistance

See Annex A

3.3 Resistance to vertical load of the whole assembled system

See Annex B

3.4 Resistance to vertical load of skin element fixings

See Annex C.1

3.5 Resistance to horizontal load of skin element fixings

See Annex C.2

3.6 Resistance to pulsating load of skin element fixings

No performance determined.

3.7 Resistance of skin element fixings in case of inaccuracies of installation

No performance determined.

3.8 Pull-through resistance of fixings (from profiles)

No performance determined.

3.9 Pull-out resistance of fixings (from profiles)

No performance determined.

3.10 Inertia and resistance of profiles

See Annex D

3.11 Resistance to vertical load of brackets

See Annex E.

3.12 Resistance to horizontal load of brackets

See Annex F.

3.13 Mechanical characteristics of subframe fixings

See Annex G.

3.14 Corrosion

Aluminium (EN AW 6063-T66):

at least corrosion category C4 (suitable for coastal areas) according EN ISO 13195

Stainless steel:

at least corrosion category C4 (suitable for coastal areas) according EN ISO EN ISO 9223

4 Assessment and verification of constancy of performance (hereinafter AVCP) system applied, with reference to its legal base

According to the Decision 2003/640/EC¹, amended of the European Commission, as amended, the system(s) of assessment and verification of constancy of performance (see Annex V of Regulation (EU) No 305/2011) is given in the following table.

Product(s)	Intended use(s)	Level(s) or class(es)	System of assessment and verification of constancy of performance
MFT-FOX V and MFT-FOX VI	Subframe and fixing kits for mechanical fastening of skin elements	any	2+

5 Technical details necessary for the implementation of the AVCP system, as provided for in the applicable EAD

Technical details necessary for the implementation of the AVCP system are laid down in the control plan deposited with the Technical Assessment Body Österreichisches Institut für Bautechnik.

Issued in Vienna on 31.03.2023
by Österreichisches Institut für Bautechnik

The original document is signed by:

Rainer Mikulits
Managing Director

¹ Official Journal of the European Communities no. L 226, 10.9.2003, p. 21-23

electronic copy

Annex A - Wind load resistance

System	Bracket	1 st layer	2 nd layer	Connector 1	Connector 2	Skin element fixing
2L-Rivet-Screw	MFT-FOX V 294 M 6.5/11	MFT-L 60x40 2.00	MFT-Z 40x29.8 1.9	S-AD 01 S (SS) 5.5x19	S-MD 51 LS (LSS) 5.5x25	Rivets
2L-Heavy Stone	MFT-FOX V 294 M 6.5/11	MFT-L 60x40 2.00	MFT-HS SPB	S-AD 01 S (SS) 5.5x19	S-MD 51 LS (LSS) 5.5x25	MFT-HS SPB
2L-SZ20	MFT-FOX V 294 M 6.5/11	MFT-L 60x40 2.00	MFT-SZ20	S-AD 01 S (SS) 5.5x19	S-MD 51 LS (LSS) 5.5x25	MFT-SZ20
2L-Hanger-22	MFT-FOX V 294 M 6.5/11	MFT-L 60x40 2.00	MFT-HP 22.5x63.5	S-AD 01 S (SS) 5.5x19	S-MD 51 LS (LSS) 5.5x25	MFT-H 50 RL
2L-Hanger-34	MFT-FOX V 294 M 6.5/11	MFT-L 60x40 2.00	MFT-HP 33x63.5	S-AD 01 S (SS) 5.5x19	S-MD 51 LS (LSS) 5.5x25	MFT-H 50 RL
1L-Clamps	MFT-FOX VI 300 M 6.5/11	MFT-L 60x40 2.00	-	S-AD 01 S (SS) 5.5x19	-	MFT-CVM 9-12 A2 MFT-CVB 9-12 A2
1L-Rivet-Screw	MFT-FOX V 294 M 6.5/11	MFT-L 60x40 2.00	-	S-AD 01 S (SS) 5.5x19	-	Rivets

2L-Rivet-Screw	WIND PRESSURE			WIND SUCTION		
Failure load (Q) and type of failure	3800 Pa without failure			1200 Pa without failure		
Maximum permanent deflection (Under load)	Between brackets	Middle bracket		Between brackets	Middle bracket	
	14.40 mm	11.77 mm		9.11 mm	10.01 mm	
Maximum permanent deflection (After 60 s of recovery)	Between brackets	Middle bracket		Between brackets	Middle bracket	
	10.36 mm	9.51 mm		7.78 mm	8.49 mm	
Maximum wind load and resistance (Q) maximum deflection	Deflection	Sensor positions		Deflection	Sensor positions	
	[mm]	Between brackets	Middle bracket	[mm]	Between brackets	Middle bracket
		[Pa]	[Pa]		[Pa]	[Pa]
	1.00	412	429	1.00	188	183
	3.00	1151	1301	3.00	494	480
5.00	1590	1622	5.00	463	463	

2L-Heavy Stone	WIND PRESSURE			WIND SUCTION		
Failure load (Q) and type of failure	5200 Pa without failure			2400 Pa without failure		
Maximum permanent deflection (Under load)	Between brackets	Middle bracket		Between brackets	Middle bracket	
	27.15 mm	13.93 mm		10.23 mm	11.80 mm	
Maximum permanent deflection (After 60 s of recovery)	Between brackets	Middle bracket		Between brackets	Middle bracket	
	24.88 mm	12.48 mm		8.91 mm	9.69 mm	
Maximum wind load and resistance (Q) maximum deflection	Deflection	Sensor positions		Deflection	Sensor positions	
	[mm]	Between brackets	Middle bracket	[mm]	Between brackets	Middle bracket
		[Pa]	[Pa]		[Pa]	[Pa]
	1.00	470	319	1.00	276	256
	3.00	1241	1624	3.00	464	464
5.00	1732	2151	5.00	1234	1187	

2L-SZ20	WIND PRESSURE			WIND SUCTION		
Failure load (Q) and type of failure	1400 Pa without failure			2200 Pa without failure		
Maximum permanent deflection (Under load)	Between brackets	Middle bracket		Between brackets	Middle bracket	
	2.53 mm	3.37 mm		5.66 mm	7.12 mm	
Maximum permanent deflection (After 60 s of recovery)	Between brackets	Middle bracket		Between brackets	Middle bracket	
	2.45 mm	3.03 mm		5.53 mm	6.79 mm	
Maximum wind load and resistance (Q) maximum deflection	Deflection	Sensor positions		Deflection	Sensor positions	
		Between brackets	Middle bracket		Between brackets	Middle bracket
	[mm]	[Pa]	[Pa]	[mm]	[Pa]	[Pa]
	1.00	389	397	1.00	422	492
	3.00	1181	473	3.00	1578	1212
5.00	1463	NPD	5.00	2052	1798	

2L-Hanger-22	WIND PRESSURE			WIND SUCTION		
Failure load (Q) and type of failure	2800 Pa without failure			2800 Pa without failure		
Maximum permanent deflection (Under load)	Between brackets	Middle bracket		Between brackets	Middle bracket	
	9.62 mm	9.79 mm		13.72 mm	20.25 mm	
Maximum permanent deflection (After 60 s of recovery)	Between brackets	Middle bracket		Between brackets	Middle bracket	
	9.07 mm	9.50 mm		11.77 mm	17.16 mm	
Maximum wind load and resistance (Q) maximum deflection	Deflection	Sensor positions		Deflection	Sensor positions	
		Between brackets	Middle bracket		Between brackets	Middle bracket
	[mm]	[Pa]	[Pa]	[mm]	[Pa]	[Pa]
	1.00	429	226	1.00	336	265
	3.00	1180	470	3.00	594	384
5.00	1691	1379	5.00	1430	989	

2L-Hanger-34	WIND PRESSURE			WIND SUCTION		
Failure load (Q) and type of failure	2400 Pa without failure			2600 Pa without failure		
Maximum permanent deflection (Under load)	Between brackets	Middle bracket		Between brackets	Middle bracket	
	8.71 mm	8.73 mm		11.83 mm	15.16 mm	
Maximum permanent deflection (After 60 s of recovery)	Between brackets	Middle bracket		Between brackets	Middle bracket	
	8.71 mm	8.59 mm		10.38 mm	13.04 mm	
Maximum wind load and resistance (Q) maximum deflection	Deflection	Sensor positions		Deflection	Sensor positions	
		Between brackets	Middle bracket		Between brackets	Middle bracket
	[mm]	[Pa]	[mm]	[mm]	[Pa]	[Pa]
	1.00	320	264	1.00	371	274
	3.00	1384	604	3.00	973	508
5.00	1824	1488	5.00	1580	1262	

1L-Clamps		WIND PRESSURE			WIND SUCTION		
Failure load (Q) and type of failure		3400 Pa without failure			1800 Pa without failure		
Maximum permanent deflection (Under load)	Between brackets	-		Between brackets	-		
	7.45 mm	-		2.66 mm	-		
Maximum permanent deflection (After 60 s of recovery)	Between brackets	-		Between brackets	-		
	6.94 mm	-		2.58 mm	-		
Maximum wind resistance (Q) load and maximum deflection	Deflection	Sensor positions		Deflection	Sensor positions		
		Between brackets	Middle bracket		Between brackets	Middle bracket	
	[mm]	[Pa]	[Pa]	[mm]	[Pa]	[Pa]	
	1.00	354	-	1.00	NPD	-	
	3.00	1995	-	3.00	NPD	-	
5.00	2655	-	5.00	NPD	-		

1L-Rivet-Screw		WIND PRESSURE			WIND SUCTION		
Failure load (Q) and type of failure		5200 Pa without failure			4400 Pa without failure		
Maximum permanent deflection (Under load)	Between brackets	-		Between brackets	-		
	10.22 mm	-		30.82 mm	-		
Maximum permanent deflection (After 60 s of recovery)	Between brackets	-		Between brackets	-		
	8.87 mm	-		25.87 mm	-		
Maximum wind resistance (Q) load and maximum deflection	Deflection	Sensor positions		Deflection	Sensor positions		
		Between brackets	Middle bracket		Between brackets	Middle bracket	
	[mm]	[Pa]	[Pa]	[mm]	[Pa]	[Pa]	
	1.00	419	-	1.00	470	-	
	3.00	1763	-	3.00	1285	-	
5.00	2981	-	5.00	1794	-		

Annex B – Resistance to vertical load of the whole assembled system

The experimental values of resistance to the vertical load of the whole assembled system were determined on the weakest test specimen, where two MFT-FOX V 294 M 6.5/11 brackets were connected with a 120/60/2 T-profile and fixed at each fixation point with two pieces of S-AD 01 S 5.5x16 screws; distance between the brackets were 1120 mm.

Resistance limit to vertical load (R_v) and belonging displacements (plastic deformation)	Displacement [mm]	Force [N]
		1.00
Failure load (F_t)	2199 N	
Dead load of the generic skin element (Q_w)	0 N	
Number of skin element fixings (N)	2 pieces	
Additional dead load (Q_{ad})	2023 N	

Annex C – Resistance of skin element fixings

Annex C.1 - Resistance to the vertical load of skin element fixings

Skin element fixing	1 mm deflection		Failure load	
	Mean force F_m [N]	Characteristic force F_c [N]	Mean force F_m [N]	Characteristic force F_c [N]
<i>MFT-CVM 9-12 A2</i>	224	175	468	425
<i>MFT-CVB 9-12 A2</i>	233	211	336	259
<i>MFT-CHM 8,5 A2</i>	401	319	629	514
<i>MFT-CHB 8,5 A2</i>	671	634	1486	1451
<i>MFT-SPM 38 6m *</i>	582	398	4032	3349
<i>MFT-SPB 38 6m *</i>	231	162	1549	1155
<i>MFT-SPT 38 6m</i>	NPD	NPD	NPD	NPD
<i>MFT-SPJ_MFT-SPT 38 6m *</i>	348	262	2236	1463
<i>MFT-B SZ 20</i>	NPD	NPD	NPD	NPD
<i>MFT-Z SZ 20 *</i>	455	393	3147	2493
<i>MFT-H 40 RL8,5</i>	856	506	4637	4470
<i>MFT-H 40 K</i>	689	358	3050	2642
<i>MFT-H 50 T</i>	322	165	1629	1449
<i>MFT-HAF 80 T</i>	1576	1209	6025	5575
<i>MFT-H 150 K</i>	1447	1030	12817	10936

* Distributed load

Annex C.2 - Resistance to the horizontal load of skin element fixings

WIND PRESSURE				
Type	1 mm deflection		Failure load	
	Mean force	Characteristic force	Mean force	Characteristic force
	F_m [N]	F_c [N]	F_m [N]	F_c [N]
MFT-CVM 9-12 A2	NPD	NPD	NPD	NPD
MFT-CVB 9-12 A2	NPD	NPD	NPD	NPD
MFT-CHM 8,5 A2	379	256	902	689
MFT-CHB 8,5 A2	393	325	697	603
MFT-SPM 38 6m **	198	189	3211	3169
MFT-SPB 38 6m **	97	86	1188	1093
MFT-SPT 38 6m **	99	95	741	685
MFT-SPJ_MFT-SPT 38 6m **	186	178	2469	2305
MFT-B SZ 20 m *	658	534	6486	5131
MFT-Z SZ 20 *	692	656	5031	3086
MFT-Z SZ 20 (2) **	152	129	2142	1690
MFT-H 40 RL8,5	1192	516	2719	2073
MFT-H 40 K	NPD	NPD	NPD	NPD
MFT-H 50 T	NPD	NPD	NPD	NPD
MFT-HAF 80 T	NPD	NPD	NPD	NPD
MFT-H 150 K	NPD	NPD	NPD	NPD

* Distributed load

** Punctual load applied in the centre

WIND SUCTION				
Type	1 mm deflection		Failure load	
	Mean force	Characteristic force	Mean force	Characteristic force
	F_m [N]	F_c [N]	F_m [N]	F_c [N]
MFT-CVM 9-12 A2	223	145	846	717
MFT-CVB 9-12 A2	125	87	681	575
MFT-CHM 8,5 A2	464	411	1066	910
MFT-CHB 8,5 A2	352	331	1092	1031
MFT-SPM 38 6m *	1185	824	5331	3370
MFT-SPB 38 6m *	963	624	5538	5201
MFT-SPT 38 6m *	380	337	2466	2235
MFT-SPJ_MFT-SPT 38 6m *	613	276	4158	1016
MFT-B SZ 20 *	445	401	3318	3122
MFT-Z SZ 20 **	310	270	3448	3082
MFT-H 40 RL8,5	407	348	2092	1896
MFT-H 40 K – fully inserted	573	471	1493	1145
MFT-H 40 K – with offset***	373	311	1280	1118
MFT-H 50 T – fully inserted	768	647	2310	1997
MFT-H 50 T – with offset***	407	317	2191	1956
MFT-HAF 80 T – fully inserted	980	590	3398	2042
MFT-HAF 80 T – with offset***	646	439	2130	1527
MFT-H 150 K – fully inserted	1466	1135	6456	5886
MFT-H 150 K – with offset	992	871	3423	2673

* Distributed load

** Punctual load applied in the centre

*** Hangers tested with the maximum adjustment offset allowed in IFU

Annex D – Inertia and resistance of profiles

MFT-FOX V 34	
Section area (A)	256.59 mm ²
Elastic modulus (W _y)	765.48 mm ³
Elastic modulus (W _z)	1825.85 mm ³
Inertia (I _y)	20791.33 mm ⁴
Inertia (I _z)	52298.30 mm ⁴
MFT-FOX V 54	
Section area (A)	324.60 mm ²
Elastic modulus (W _y)	1923.98 mm ³
Elastic modulus (W _z)	1947.30 mm ³
Inertia (I _y)	79350.84 mm ⁴
Inertia (I _z)	60004.88 mm ⁴
MFT-FOX V 74	
Section area (A)	381.68 mm ²
Elastic modulus (W _y)	3875.94 mm ³
Elastic modulus (W _z)	2032.25 mm ³
Inertia (I _y)	206634.56 mm ⁴
Inertia (I _z)	66750.06 mm ⁴
MFT-FOX V 94	
Section area (A)	440.69 mm ²
Elastic modulus (W _y)	6122.49 mm ³
Elastic modulus (W _z)	2086.67 mm ³
Inertia (I _y)	400120.29 mm ⁴
Inertia (I _z)	71097.62 mm ⁴
MFT-FOX V 114	
Section area (A)	522.16 mm ²
Elastic modulus (W _y)	8824.61 mm ³
Elastic modulus (W _z)	2125.94 mm ³
Inertia (I _y)	678830.13 mm ⁴
Inertia (I _z)	74430.01 mm ⁴
MFT-FOX V 134	
Section area (A)	586.17 mm ²
Elastic modulus (W _y)	11969.12 mm ³
Elastic modulus (W _z)	2155.74 mm ³
Inertia (I _y)	1055395.45 mm ⁴
Inertia (I _z)	77068.46 mm ⁴
MFT-FOX V 154	
Section area (A)	650.48 mm ²
Elastic modulus (W _y)	15545.64 mm ³
Elastic modulus (W _z)	2179.19 mm ³
Inertia (I _y)	1542126.51 mm ⁴
Inertia (I _z)	79211.60 mm ⁴

MFT-FOX V 174	
Section area (A)	803.71 mm ²
Elastic modulus (W _y)	19546.26 mm ³
Elastic modulus (W _z)	2198.18 mm ³
Inertia (I _y)	2151152.31 mm ⁴
Inertia (I _z)	80988.84 mm ⁴
MFT-FOX V 194	
Section area (A)	878.21 mm ²
Elastic modulus (W _y)	23964.86 mm ³
Elastic modulus (W _z)	2213.92 mm ³
Inertia (I _y)	2894493.20 mm ⁴
Inertia (I _z)	82488.13 mm ⁴
MFT-FOX V 214	
Section area (A)	952.71 mm ²
Elastic modulus (W _y)	28796.71 mm ³
Elastic modulus (W _z)	2227.22 mm ³
Inertia (I _y)	3784101.21 mm ⁴
Inertia (I _z)	83771.33 mm ⁴
MFT-FOX V 234	
Section area (A)	1123.19 mm ²
Elastic modulus (W _y)	34038.13 mm ³
Elastic modulus (W _z)	2238.65 mm ³
Inertia (I _y)	4831883.58 mm ⁴
Inertia (I _z)	84883.21 mm ⁴
MFT-FOX V 254	
Section area (A)	1206.90 mm ²
Elastic modulus (W _y)	39686.20 mm ³
Elastic modulus (W _z)	2248.59 mm ³
Inertia (I _y)	6049717.27 mm ⁴
Inertia (I _z)	85856.96 mm ⁴
MFT-FOX V 274	
Section area (A)	1289.19 mm ²
Elastic modulus (W _y)	45738.54 mm ³
Elastic modulus (W _z)	2257.34 mm ³
Inertia (I _y)	7449458.15 mm ⁴
Inertia (I _z)	86717.73 mm ⁴
MFT-FOX V 294	
Section area (A)	1403.43 mm ²
Elastic modulus (W _y)	52193.23 mm ³
Elastic modulus (W _z)	2265.13 mm ³
Inertia (I _y)	9042946.99 mm ⁴
Inertia (I _z)	87484.91 mm ⁴

Annex E - Resistance to vertical loads of brackets

Dead load

Bracket name	Length L [mm]	Size	Characteristic component resistance R_k [N]
MFT-FOX V 34 S	34	S	NPD
MFT-FOX V 54 S	54	S	NPD
MFT-FOX V 74 S	74	S	NPD
MFT-FOX V 94 S	94	S	NPD
MFT-FOX V 114 S	114	S	NPD
MFT-FOX V 134 S	134	S	NPD
MFT-FOX V 154 S	154	S	NPD
MFT-FOX V 174 S	174	S	NPD
MFT-FOX V 194 S	194	S	NPD
MFT-FOX V 214 S	214	S	NPD
MFT-FOX V 234 S	234	S	NPD
MFT-FOX V 254 S	254	S	NPD
MFT-FOX V 274 S	274	S	NPD
MFT-FOX V 294 S	294	S	NPD
MFT-FOX V 34 M	34	M	5005
MFT-FOX V 54 M*	54	M	4132
MFT-FOX V 74 M*	74	M	3521
MFT-FOX V 94 M*	94	M	3001
MFT-FOX V 114 M*	114	M	2557
MFT-FOX V 134 M*	134	M	2179
MFT-FOX V 154 M*	154	M	1857
MFT-FOX V 174 M	174	M	1460
MFT-FOX V 194 M*	194	M	1348
MFT-FOX V 214 M*	214	M	1149
MFT-FOX V 234 M*	234	M	979
MFT-FOX V 254 M*	254	M	834
MFT-FOX V 274 M*	274	M	711
MFT-FOX V 294 M	294	M	621
MFT-FOX V 34 L	34	L	9529
MFT-FOX V 54 L*	54	L	8373
MFT-FOX V 74 L*	74	L	7426
MFT-FOX V 94 L*	94	L	6586
MFT-FOX V 114 L*	114	L	5842
MFT-FOX V 134 L*	134	L	5181
MFT-FOX V 154 L*	154	L	4595
MFT-FOX V 174 L	174	L	4303
MFT-FOX V 194 L*	194	L	3615
MFT-FOX V 214 L*	214	L	3206
MFT-FOX V 234 L*	234	L	2843
MFT-FOX V 254 L*	254	L	2522
MFT-FOX V 274 L*	274	L	2237
MFT-FOX V 294 L	294	L	2165
MFT-FOX VI 180 S	180	S	NPD
MFT-FOX VI 180 M	180	M	1064
MFT-FOX VI 180 L	180	L	3190

*Interpolated data

Annex F - Resistance to horizontal loads of brackets**Wind suction**

Bracket name	Length L [mm]	Size	Characteristic component resistance R_k [N]
MFT-FOX V 34 S	34	S	5293
MFT-FOX V 54 S*	54	S	5543
MFT-FOX V 74 S*	74	S	5768
MFT-FOX V 94 S*	94	S	5967
MFT-FOX V 114 S*	114	S	6141
MFT-FOX V 134 S*	134	S	6289
MFT-FOX V 154 S*	154	S	6411
MFT-FOX V 174 S	174	S	6507
MFT-FOX V 194 S*	194	S	6579
MFT-FOX V 214 S*	214	S	6625
MFT-FOX V 234 S*	234	S	6645
MFT-FOX V 254 S*	254	S	6639
MFT-FOX V 274 S*	274	S	6608
MFT-FOX V 294 S	294	S	6548
MFT-FOX V 34 M	34	M	6305
MFT-FOX V 54 M*	54	M	6604
MFT-FOX V 74 M*	74	M	6868
MFT-FOX V 94 M*	94	M	7095
MFT-FOX V 114 M*	114	M	7286
MFT-FOX V 134 M*	134	M	7442
MFT-FOX V 154 M*	154	M	7561
MFT-FOX V 174 M	174	M	7944
MFT-FOX V 194 M*	194	M	7690
MFT-FOX V 214 M*	214	M	7701
MFT-FOX V 234 M*	234	M	7676
MFT-FOX V 254 M*	254	M	7615
MFT-FOX V 274 M*	274	M	7517
MFT-FOX V 294 M	294	M	7385
MFT-FOX V 34 L	34	L	6977
MFT-FOX V 54 L*	54	L	7489
MFT-FOX V 74 L*	74	L	7928
MFT-FOX V 94 L*	94	L	8293
MFT-FOX V 114 L*	114	L	8584
MFT-FOX V 134 L*	134	L	8802
MFT-FOX V 154 L*	154	L	8946
MFT-FOX V 174 L	174	L	9017
MFT-FOX V 194 L*	194	L	9013
MFT-FOX V 214 L*	214	L	8936
MFT-FOX V 234 L*	234	L	8786
MFT-FOX V 254 L*	254	L	8562
MFT-FOX V 274 L*	274	L	8265
MFT-FOX V 294 L	294	L	7896
MFT-FOX VI 180 S	180	S	6585
MFT-FOX VI 180 M	180	M	7694
MFT-FOX VI 180 L	180	L	9306

*Interpolated data

Wind pressure

Bracket name	Length L [mm]	Size	Characteristic component resistance R_k [N]
MFT-FOX VI 40 S	40	S	16360
MFT-FOX VI 60 S*	60	S	13516
MFT-FOX VI 80 S*	80	S	12012
MFT-FOX VI 100 S*	100	S	10962
MFT-FOX VI 120 S*	120	S	10172
MFT-FOX VI 140 S	140	S	9119
MFT-FOX VI 160 S*	160	S	9041
MFT-FOX VI 180 S*	180	S	8614
MFT-FOX VI 200 S*	200	S	8250
MFT-FOX VI 220 S	220	S	7652
MFT-FOX VI 240 S*	240	S	7656
MFT-FOX VI 260 S*	260	S	7409
MFT-FOX VI 280 S*	280	S	7187
MFT-FOX VI 300 S	300	S	7440
MFT-FOX VI 40 M	40	M	17468
MFT-FOX VI 60 M*	60	M	16415
MFT-FOX VI 80 M*	80	M	15930
MFT-FOX VI 100 M*	100	M	15446
MFT-FOX VI 120 M*	120	M	14962
MFT-FOX VI 140 M	140	M	13499
MFT-FOX VI 160 M*	160	M	13993
MFT-FOX VI 180 M*	180	M	13509
MFT-FOX VI 200 M*	200	M	13024
MFT-FOX VI 220 M	220	M	12669
MFT-FOX VI 240 M*	240	M	12055
MFT-FOX VI 260 M*	260	M	11571
MFT-FOX VI 280 M*	280	M	11087
MFT-FOX VI 300 M	300	M	10893
MFT-FOX VI 40 L	40	L	19396
MFT-FOX VI 60 L*	60	L	18443
MFT-FOX VI 80 L*	80	L	17645
MFT-FOX VI 100 L*	100	L	16914
MFT-FOX VI 120 L*	120	L	16250
MFT-FOX VI 140 L	140	L	15323
MFT-FOX VI 160 L*	160	L	15121
MFT-FOX VI 180 L*	180	L	14657
MFT-FOX VI 200 L*	200	L	14259
MFT-FOX VI 220 L	220	L	14291
MFT-FOX VI 240 L*	240	L	13664
MFT-FOX VI 260 L*	260	L	13466
MFT-FOX VI 280 L*	280	L	13335
MFT-FOX VI 300 L	300	L	13141

*Interpolated data

Annex G – Mechanical characteristics of subframe fixings

Subframe fixings S-AD01 SS 5,5x19 were tested according to EAD 090018-00-0404, section 2.2.4.4. The reported results refer to the ETA-21/0174.

The minimum number of screws and end-use parameters are presented in ETA-21/0174.

Screw type: Hilti S-AD01 SS 5,5x19 (A4)	Characteristic resistance	
	$F_{R,k,x}$ (pull out) [N]	$F_{R,k,z}$ (shear) [N]
Fixed point	3580	3580
Slide point	3280	-

Annex H - Additional drawings

Brackets

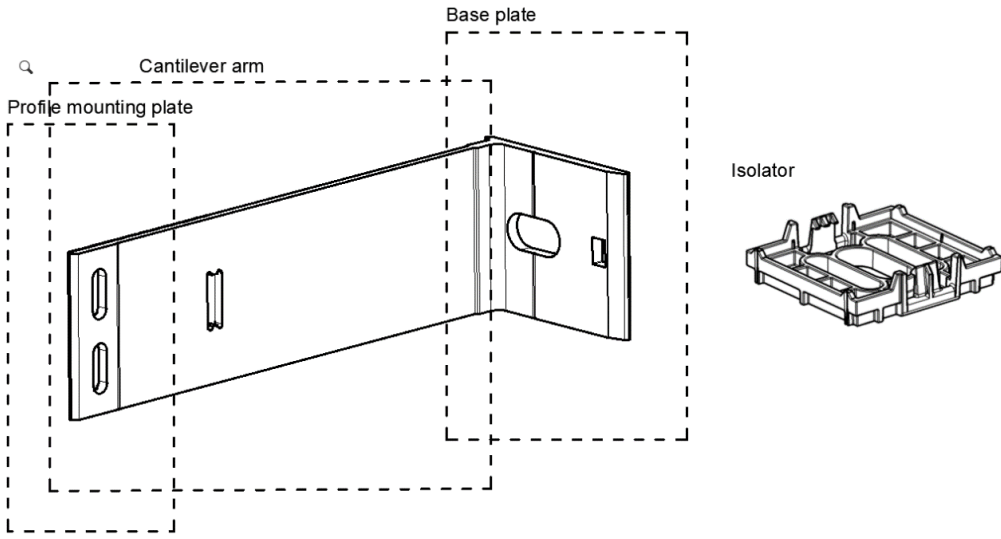

	S	M	L
MFT-FOX V			
MFT-FOX VI			

A	S	M	L
<ul style="list-style-type: none"> HRD HST KB HUS <p>∅ 11</p>			
<ul style="list-style-type: none"> SF DX HFB-R RW <p>∅ 6.5</p>			

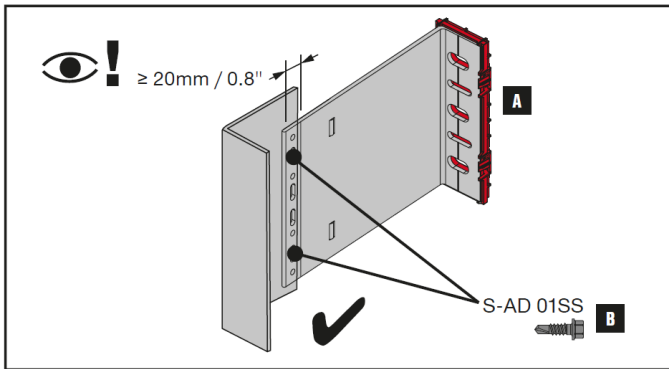

B	S	M	L
<ul style="list-style-type: none"> S-AD 01SS 			
<ul style="list-style-type: none"> S-AD 01SS 			

MFT-FOX VI Small

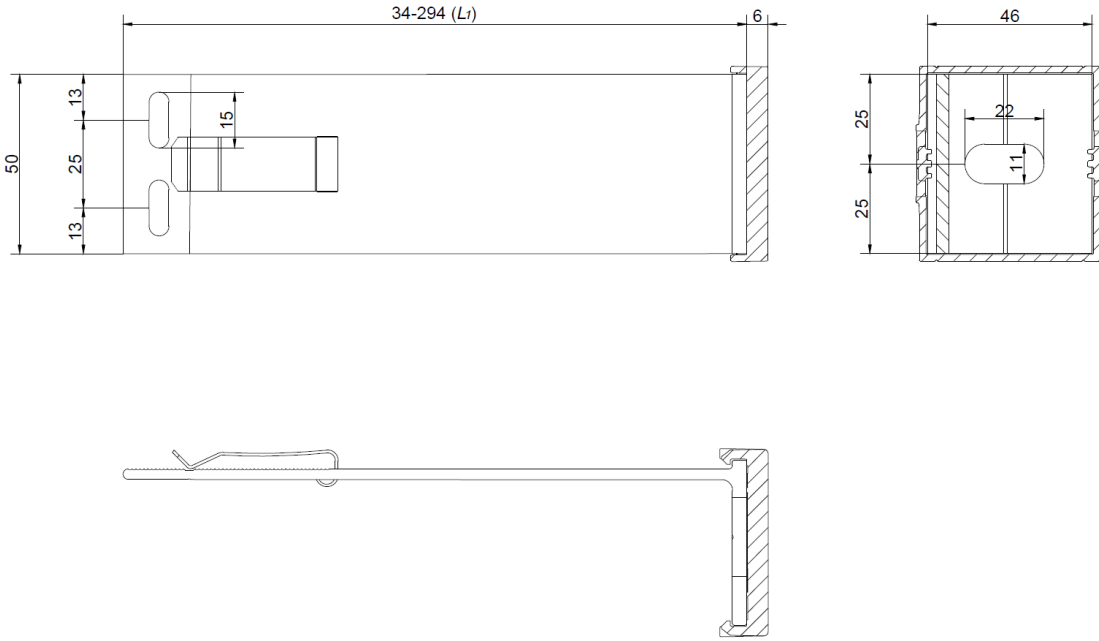

MFT-FOX VI Medium

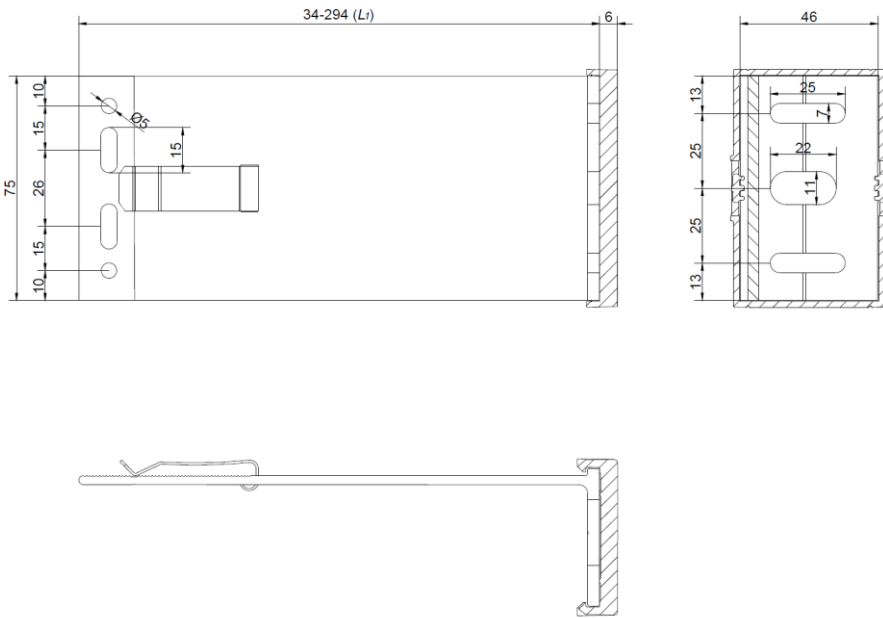

Screw connections

- a) Self-drilling screws "Hilti S-AD01 S 5,5x19 (A2)"
- b) Self-drilling screws "Hilti S-AD01 SS 5,5x19 (A4)"
- c) Self-drilling screws "Hilti S-AD01 S 5,5x16 (A2)"
- d) Self-drilling screws "Hilti S-AD01 SS 5,5x16 (A4)"
- e) Self-drilling screws "Hilti S-AD01 L(P)SS 5,5x25 (A4)"
- f) Self-drilling screws "Hilti S-AD01 LHS M (A2)"
- g) Self-drilling screws "Hilti S-AD01 LHSS 4,8x17 (A4)"

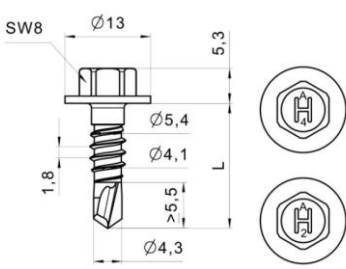

(a) (b) (c) (d)

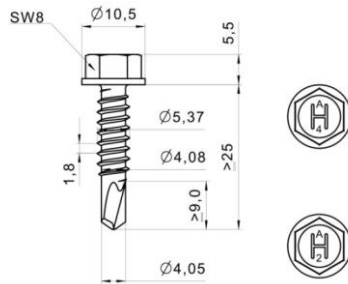

(e)

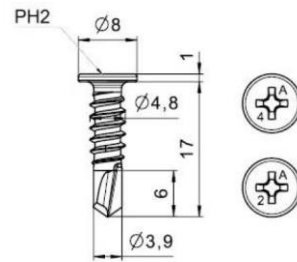

(f) (g)

Heavy stone profiles

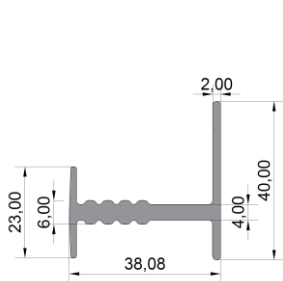

(a) Middle stone profile MFT-SPM

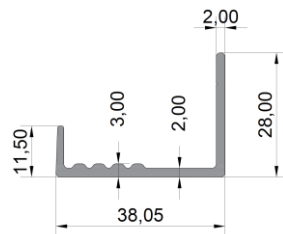

(b) Bottom stone profile MFT-SPB

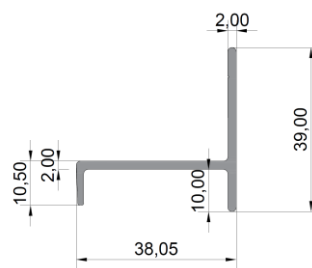

(c) Top stone profile MFT-SPT

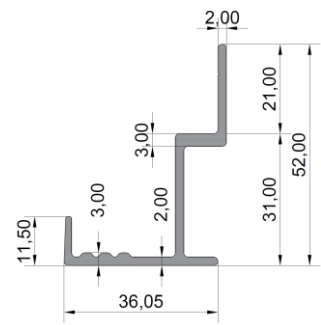

(d) Stone profile MFT-SPJ

Cassette

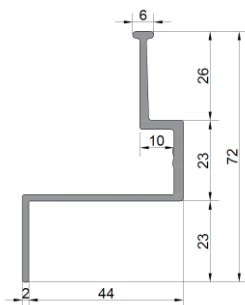

(a) MFT-Z SZ20

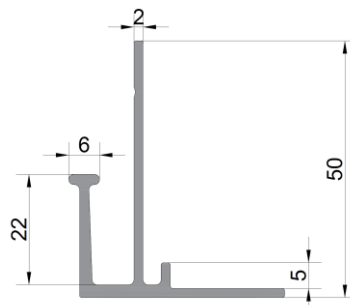

(b) MFT-B SZ20

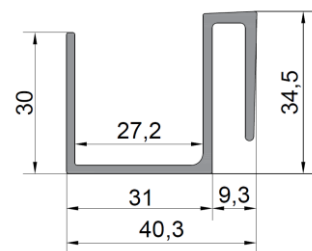

(c) MFT-S SZ20

Hangers

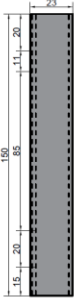
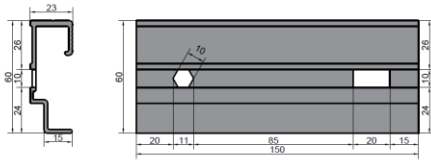

(a) MFT-H 200/150 K

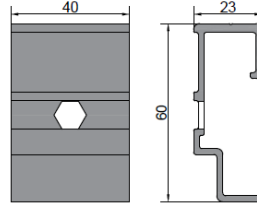

(b) MFT-H 200/40 K

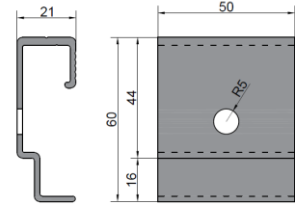

(c) MFT-H 200/50 RL 9.2

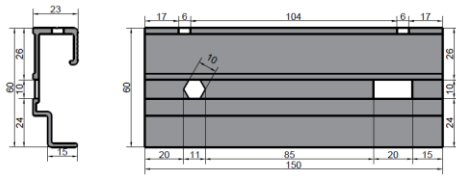

(d) MFT-HA 200/150 K

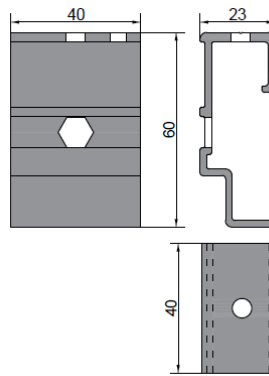

(e) MFT-HA 200/40 K

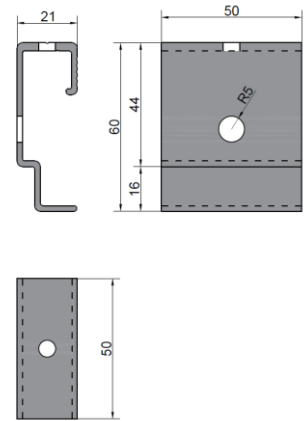

(f) MFT-HA 200/50 RL 9.2

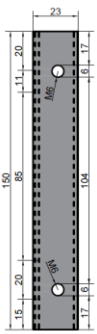

(g) MFT-HAF 200/150 K

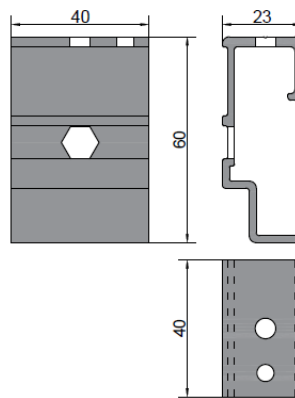

(h) MFT-HAF 200/40 K

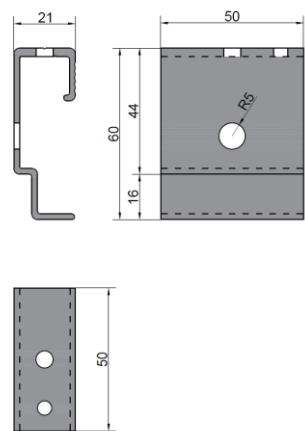

(i) MFT-HAF 200/50 RL 9.2

electronic copy electronic copy electronic copy electronic copy electronic copy electronic copy electronic copy electronic copy electronic copy electronic copy

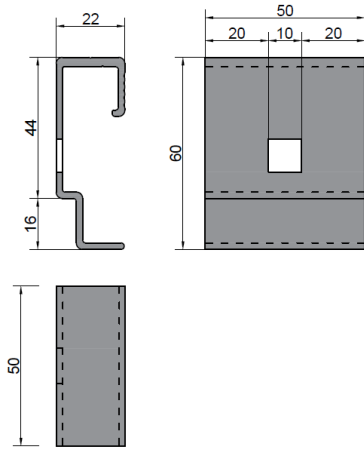

(j) MFT-H 200/50 T

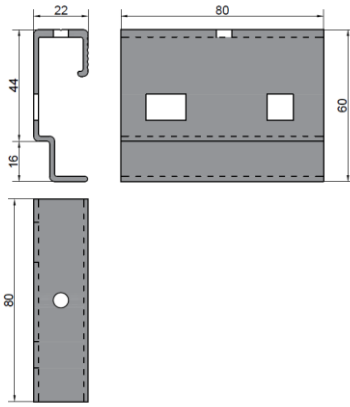

(k) MFT-HA 200/50 T

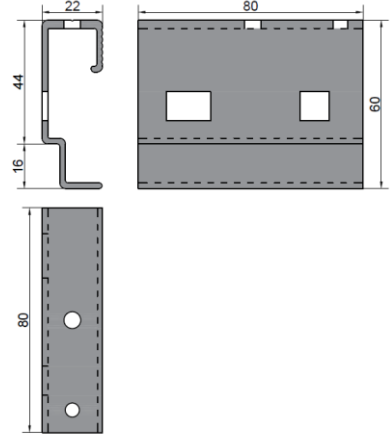

(l) MFT-HAF 200/50 T

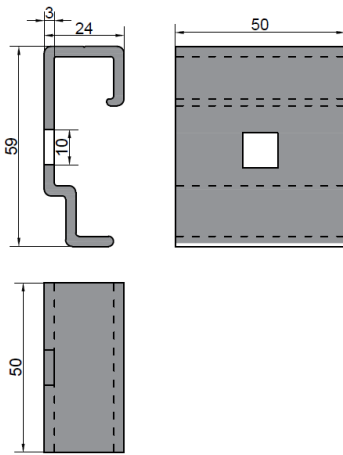

(m) MFT-H 300/50 T

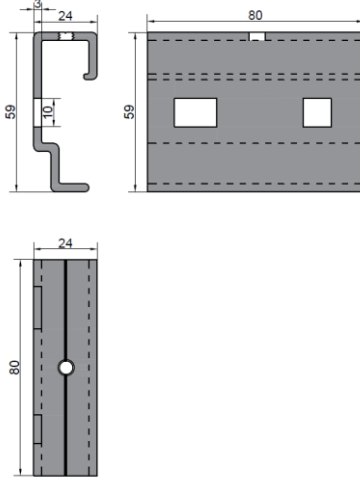

(n) MFT-HA 300/50 T

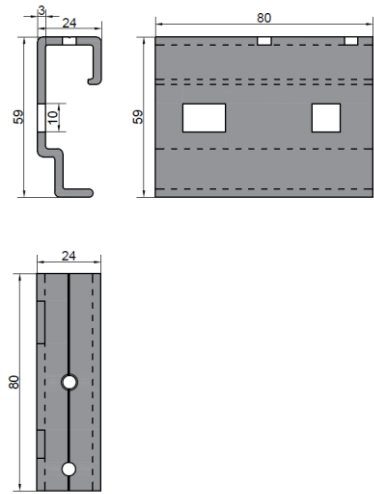

(o) MFT-HAF 300/50 T

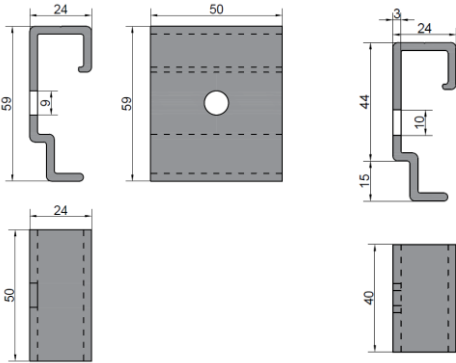

(p) MFT-H 300/50 RL 9,2

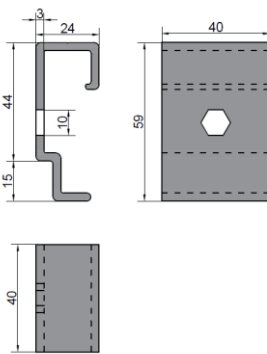

(q) MFT-H 300/40 K

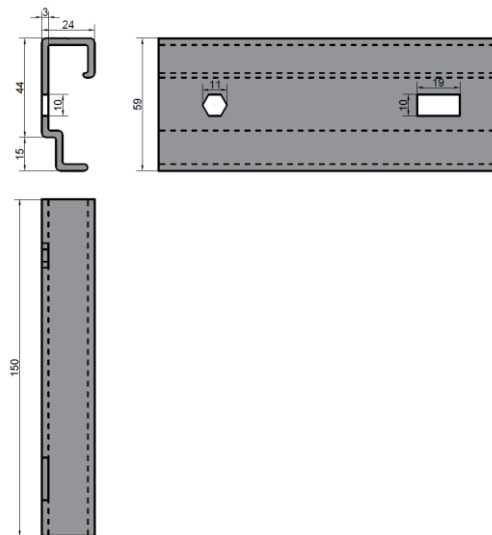

(r) MFT-H 300/150 K

electronic copy electronic copy electronic copy electronic copy electronic copy electronic copy electronic copy electronic copy electronic copy electronic copy

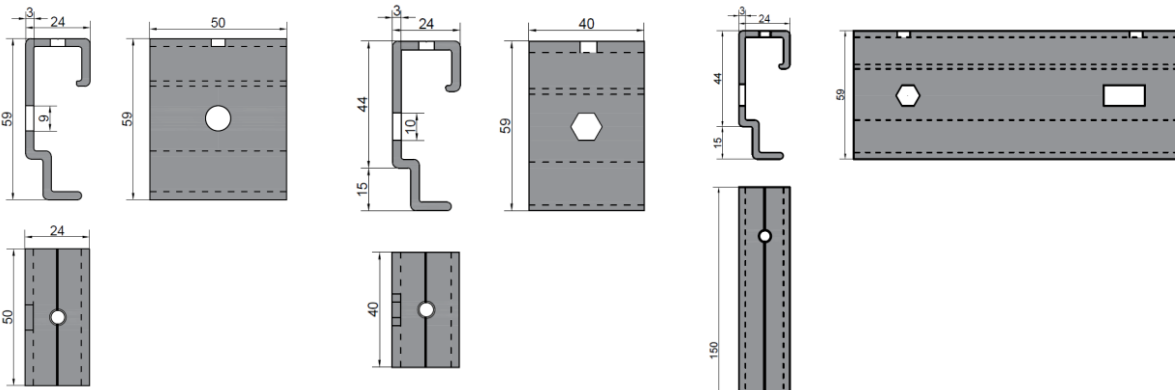

(s) MFT-HA 300/50 RL 9,2

(t) MFT-HA 300/40 K

(u) MFT-HA 300/150 K

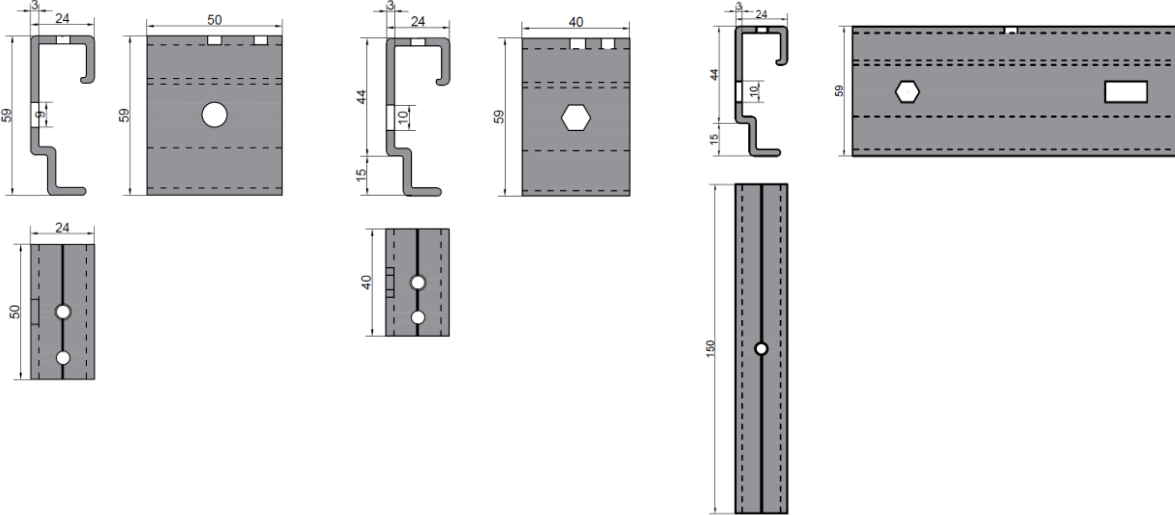

(v) MFT-HAF 300/50 RL 9,2

(x) MFT-HAF 300/40 K

(w) MFT-HAF 300/150 K

electronic copy electronic copy electronic copy electronic copy electronic copy electronic copy electronic copy electronic copy electronic copy electronic copy

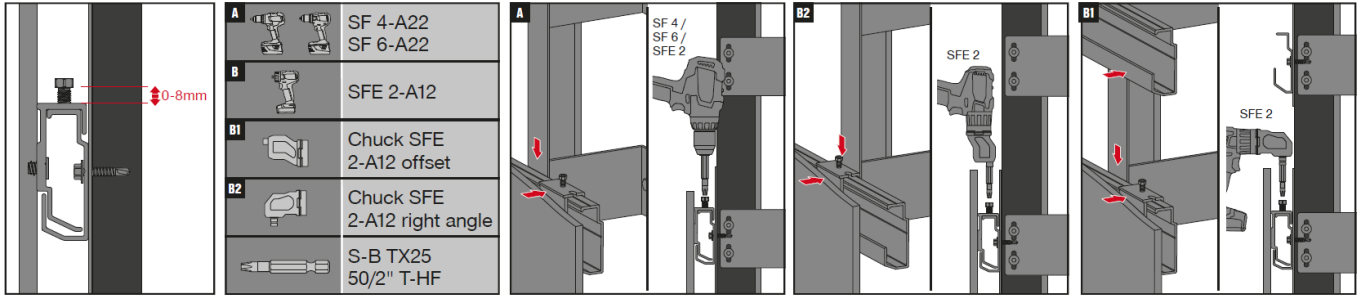

	40 RL 8,5	40 K	50 RL7	50 RL9	50 T	150 K	MFT-HP 22,5x63,5	MFT-HP 33x63,5
MFT-H								
MFT-HAF							MFT-HP 22,5x63,5 pf	MFT-HP 33x63,5 pf

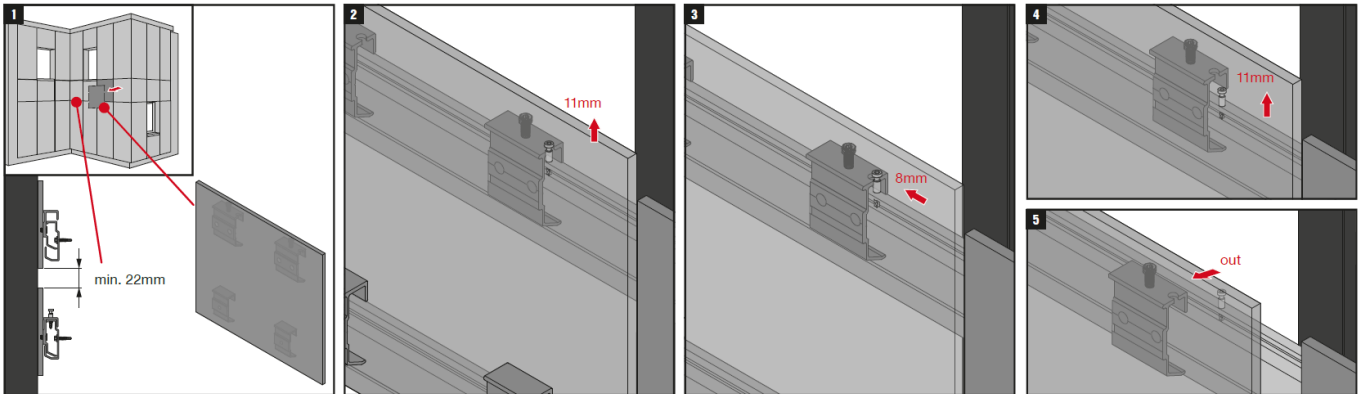
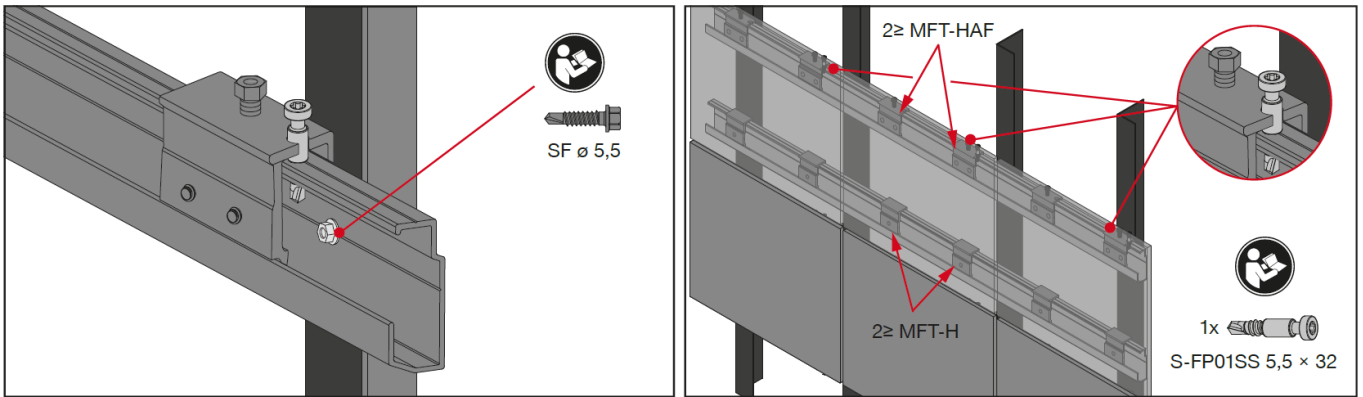

L-profiles

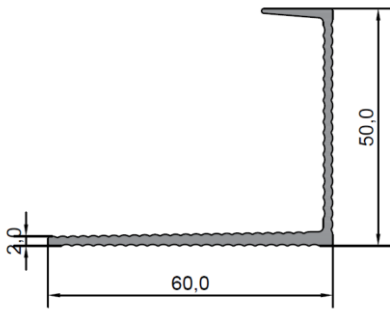

(a) MFT-L 60 x 50 x 2 mm

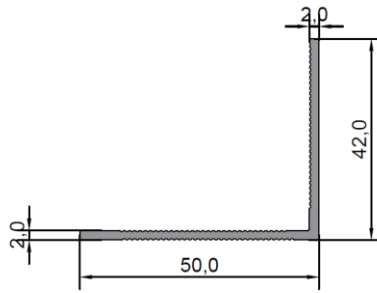

(b) MFT-L 50 x 42 x 2 mm

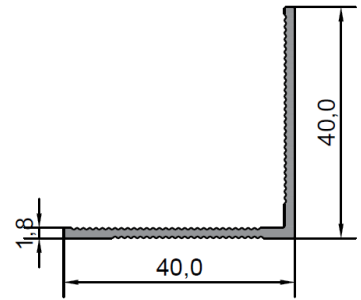

(c) MFT-L 40 x 40 x 1,8 mm

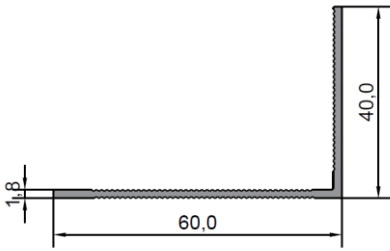

(d) MFT-L 60 x 40 x 1,8 mm

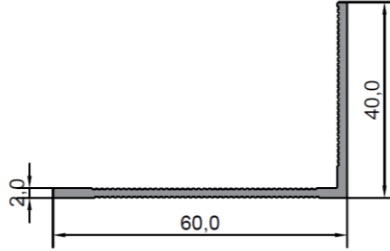

(e) MFT-L 60 x 40 x 2 mm

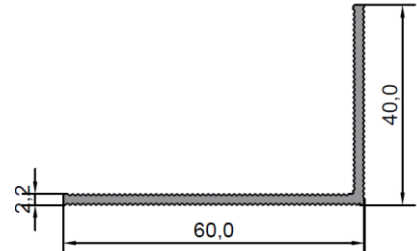

(f) MFT-L 60 x 40 x 2,2 mm

T-profiles

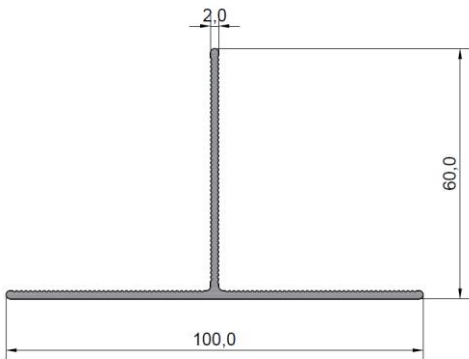

(a) MFT-T 60 x 100 x 2 mm

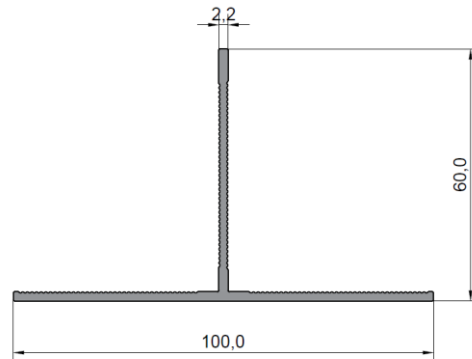

(b) MFT-T 60 x 100 x 2,2 mm

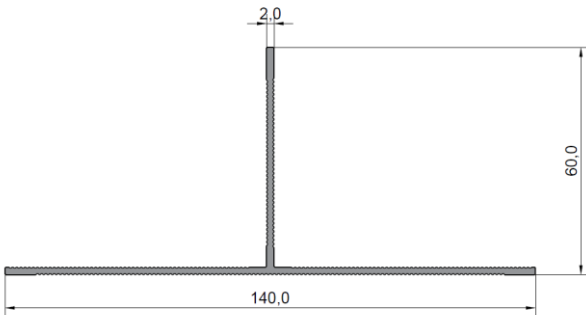

(c) MFT-T 60 x 140 x 2 mm

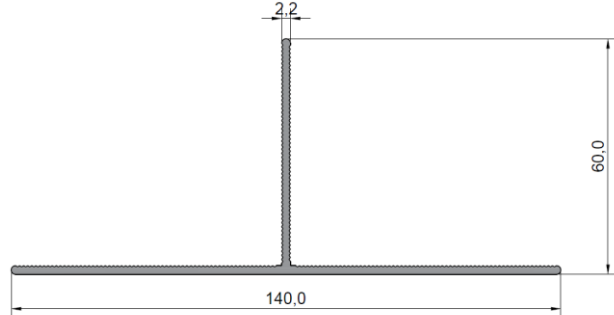

(d) MFT-T 60 x 140 x 2,2 mm